



# IN NO VA

— SEAT VALVES —



DN  
HT



# SUMMARY

> <b>INOXPA: EXCELLENCE IN HYGIENIC DESIGN</b>	4
> <b>ARGUMENTS &amp; BENEFITS</b>	6
> <b>SINGLE SEAT CONCEPT</b>	8
> <b>INNOVA N</b>	10
> <b>INNOVA M</b>	11
> <b>INNOVA K</b>	12
> <b>INNOVA L</b>	13
> <b>INNOVA G</b>	14
> <b>INNOVA J</b>	15
> <b>INNOVA F</b>	16
> <b>TABLE: INNOVA SINGLE SEAT</b>	18
> <b>MIXPROOF CONCEPT</b>	20
> <b>INNOVA P</b>	22
> <b>INNOVA S</b>	23
> <b>INNOVA T</b>	24
> <b>INNOVA R</b>	25
> <b>INNOVA D</b>	26
> <b>TABLE: MIXPROOF</b>	28
> <b>MANIFOLDS</b>	30
> <b>CTOP S</b>	32
> <b>VALVE IDENTIFICATION AND ORDER CODES</b>	34



# INOXPA: EXCELLENCE IN HYGIENIC DESIGN

Food safety must be ensured by a design made in accordance with hygienic principles in order to prevent contamination.

INOXPA have three priority objectives in the hygienic design of our components:

- To prevent the risk of physical, chemical or microbiological contamination
- To facilitate the cleaning and disinfection of the installation
- To contribute towards the preservation and maintenance of the equipment

The main factors we consider are:

- The materials of the components
- The typology and finish of the contact surfaces
- Accessibility to the components
- Drainage capacity
- Airtightness

The design of the components, equipment and installations should allow for the appropriate cleaning, disinfection and maintenance. Its construction and preservation should prevent the risk of contamination of the treated products, the accumulation of soiling and also any contact with toxic products.

## MATERIALS AND SURFACES

INOXPA use corrosion-resistant materials, that are easy to clean and that prevent the presence of microorganisms, in addition to being compatible with the treated products and with the products used for its subsequent cleaning and disinfection.



The surfaces are made of non-absorbent materials that are resistant to detergents, disinfectants and other cleaning products in order to prevent any detachment.

The surfaces are polished until low roughness is attained (equal to or less than Ra 0.8µm), the welds are left flush and blemish-free, thus steps between the different surfaces are avoided.

The material used is AISI-316L stainless steel in the parts that come into contact with the product, due to its high level of resistance to corrosion, pH and the high temperatures of the cleaning products.

#### THE CONCEPT OF "CLEANABILITY"

INOXPA take into account the cleaning and disinfection procedures to be carried out in each installation. The valves must be able to be properly cleaned by ensuring that the materials and surfaces can withstand the contact with the chemical products used for cleaning.

A flawed hygienic design will entail greater accumulation of remaining product and dirt which implies a longer cleaning process. It increases the amount of water and the detergent and disinfectant products used, which entails greater cost.

# ARGUMENTS & BENEFITS

## SEAT VALVES FOR HYGIENIC USE

INNOVA seat valves are designed to offer solutions in hygienic applications for industries in the most demanding sectors such as food, beverage, health care or pharmaceutical.

The extensive experience of **INOXPA**, with more than **40 years** introducing hundred thousand of valves in the market, is reflected in this **wide and complete range of seat valves**, which thanks to its advanced design, versatile and reliable, **meets the highest hygienic standards**.

The different **INNOVA** models **share many of their components**: bodies, shafts and gaskets, which **improves stock management as well as delivery times**. In addition, its design without internal "dead spaces" **prevents product losses and facilitates a perfect cleaning (CIP)**.

### SIMPLE & CHEAPER INSTALATION

INNOVA's advanced modular design, with the same components for different models and their multiple combinations, allows **quicker and easier assembly and commissioning with lower installation costs**.

### LOW COST LONG TERM

Thanks to its design and **quality of materials and finishes**, resources in maintenance and cleaning are reduced, as well as minimal loss of product. **Higher performance and efficiency** are also achieved by extending the life of the valve.

HYGIENIC

**INCREASE**  
CLEANING CYCLES  
CONSUMPTION  
CLEANING PRODUCTS  
WATER CONSUMPTION



**DECREASE**  
USEFULL LIFE  
OF COMPONENTS  
PRODUCTION CYCLES

**MORE AGGRESSIVE  
PRODUCTS**

**ECONOMIC LOSS**

**PERJURY TO THE ENVIRONMENT**



### LONG DURABILITY

The **advanced design** of the seals, the plug and the seat guarantee a **perfect sealing** and thanks to the **metal-metal contact** between the plug and the body, the **life cycles of the valve are extended**, which implies savings in maintenance.

### MORE HYGIENIC

The finishing of the bodies without welding marks and with internal polishing **RA 0.8 µm** reduces the presence of contamination by bacteria. The design of the rest of the components, seats and seals, allows a **total cleaning** complying with the most demanding **hygiene standards**.

### MORE BENEFITS

INNOVA valves **reduce the number of their components and share them**, which means a reduction in installation, maintenance and inventory costs. Its **design and reliability** extend the life of the valve, make it more hygienic, reducing the consumption of water and cleaning products, causing a minimum amount of product waste. **Less investment - more profit.**

### TAKING CARE OF THE ENVIROMENT

The inside of the valves without dead spaces and **polished surfaces RA 0.8µm** means less waste of product. All this implies a **high reduction in cleaning costs**, with less cleaning solutions, less water and, in general, less specific products. All this considerably **reduces the environmental impact.**

## DESIGN

**INCREASE**  
PRODUCTION CYCLES  
USEFULL LIFE  
OF COMPONENTS



**DECREASE**  
CLEANING CYCLES  
MAINTENANCE

CERTIFICATE

**MORE ECONOMIC BENEFIT AND CARE  
FOR THE ENVIRONMENT**

# SINGLE SEAT CONCEPT

INOXPA has a wide range of seat valves available, which mainly feature high productivity and lower operating and maintenance costs. They offer a consistent product quality and impeccable cleaning.

## TECHNICAL SPECIFICATIONS

### MATERIALS:

Parts in contact with the product	AISI 316L (1.4404)
Other stainless steel parts	AISI 304 (1.4301)
Gasket	EPDM - HNBR* - FPM*
Surface finish:	
Internal	Bright polish $Ra \leq 0,8 \mu m - 0,5^* \mu m$
External	Matt

### AVAILABLE SIZES:

DIN EN 10357 series A (previously DIN 11850 series 2)	DN 25 - DN 100
ASTM A269/270 (corresponds to OD pipe)	OD 1" - OD 4"

### CONNECTIONS:

Weld, Clamp\*, Male\*

### OPERATING LIMITS:

Temperature range (EPDM)	-10 °C to +121 °C
SIP temperature, max. 30 min.	140°C
Maximum working pressure	10 bar
Minimum working pressure	Vacuum
Compressed air pressure	6-8 bar

(\*) Optional

## APPLICATIONS





**INNOVA**  
SINGLE SEAT VALVES

CONTROL

ACTIVATION

PLUG

CONNECTION BODY

ACTIVATION

PLUG

BODY

**INNOVA**  
TANK BOTTOM VALVES

PLUG

CONTROL

BODY

ACTIVATION



# SHUT-OFF SINGLE SEAT VALVE



Standard Number 53-06

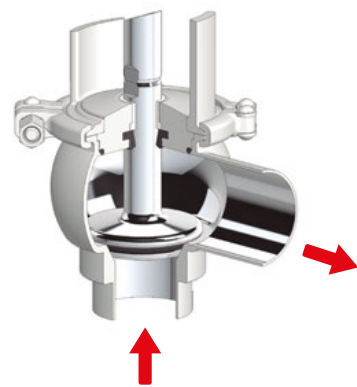

Flow inlet  
via the lower body

The valve is designed for the direction of product flow from the LOWER to the UPPER body.

In order to prevent water hammering the closing acts from the UP position to the DOWN position against the flow direction.

## HOUSING COMBINATIONS

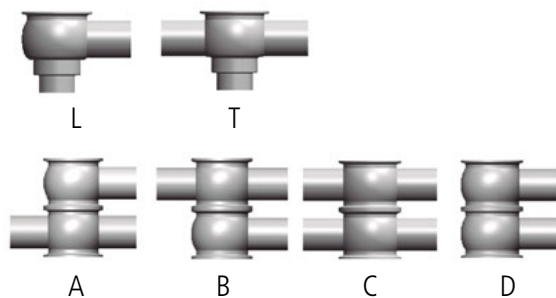

## OPTIONS

- > Double acting pneumatic actuator.
- > External position sensors.
- > Heating jacketed body.
- > Steam barrier.
- > Manual drive.
- > Twin stop.



# M

## SHUT-OFF SINGLE SEAT VALVE

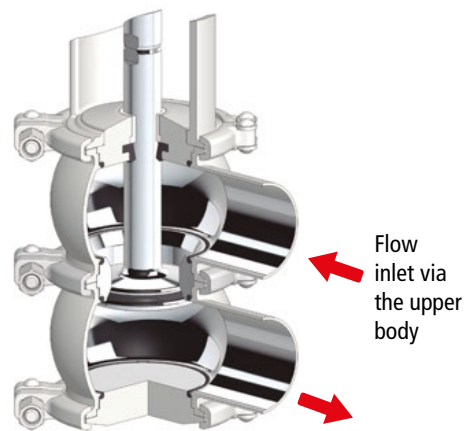

The INNOVA M-type valve is a pneumatic shut-off seat valve for hygienic applications. The valve is designed for the direction of product flow from the UPPER to the LOWER body.

In order to prevent water hammering the closing acts from the DOWN position to the UP position against the flow direction.

### HOUSING COMBINATIONS

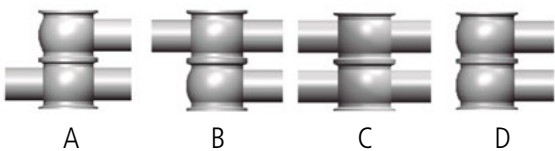

### OPTIONS

- > Double acting pneumatic actuator.
- > External position sensors.
- > Heating jacketed body.
- > Steam barrier.
- > Manual drive.
- > Twin stop.



# DIVERT SINGLE SEAT VALVE



Standard Number 53-06



Converging flow

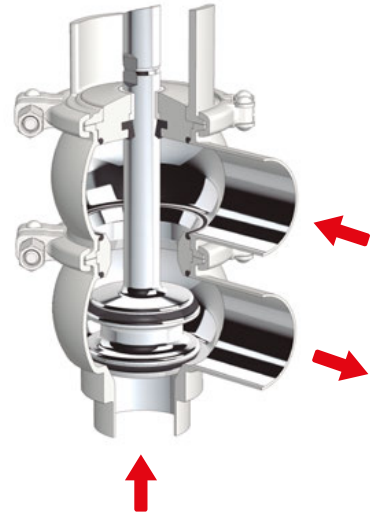

The INNOVA K-type valve is a pneumatic divert seat valve designed for hygienic applications. This valve is designed to manage converging flows, given that it closes against the direction of flow, the inlet is via the upper or lower bodies and outlet via the central body.

## HOUSING COMBINATIONS

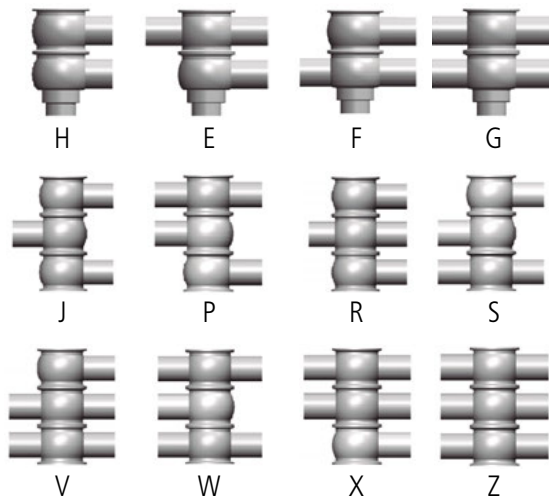

## OPTIONS

- > Double acting pneumatic actuator.
- > External position sensors.
- > Heating jacketed body.
- > Steam barrier.
- > Manual drive.
- > Twin stop.



# DIVERT SINGLE SEAT VALVE



Diverging flow

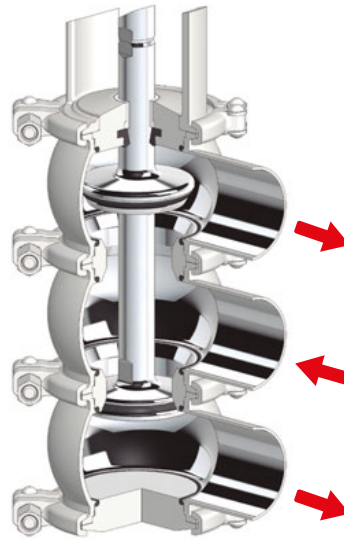

The L type valve is a pneumatic divert seat valve designed for hygienic applications. This valve is designed to manage diverging flows, given that it closes against the direction of flow, the inlet is via the central body and outlet via the upper or lower bodies.

## HOUSING COMBINATIONS

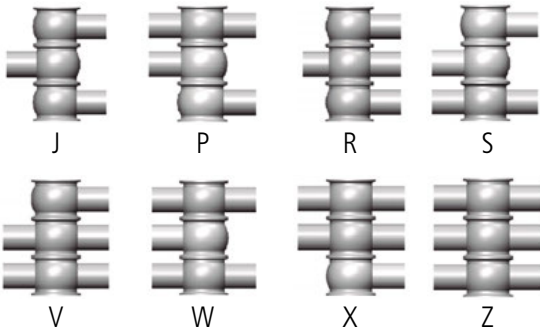

## OPTIONS

- > Double acting pneumatic actuator.
- > External position sensors.
- > Heating jacketed body.
- > Steam barrier.
- > Manual drive.
- > Twin stop.



# CONTROL SINGLE SEAT VALVE

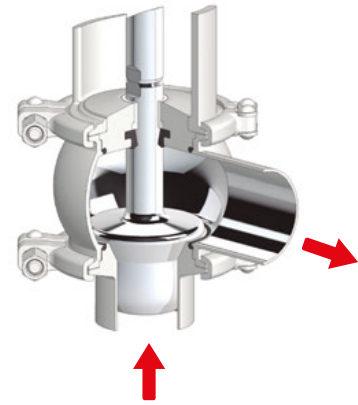

Progressive opening or adjustment

The INNOVA G-type valve is a pneumatic flow control single seat valve for hygienic applications. Its main function involves regulating flow, controlling pressure and level. The plug's design enables equal percentage flow control to obtain the required Kv factor. This type of control is recommended for systems with significant flow or differential pressure variations. Positioning is controllable either manually or using a process parameter via the positioning sensor.

## HOUSING COMBINATIONS

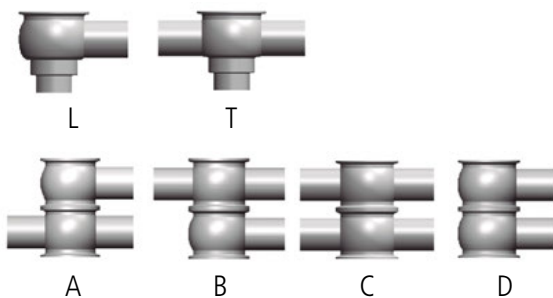

## OPTIONS

- > Double acting pneumatic actuator.
- > Heating jacketed body.
- > Steam barrier.
- > Seat seal.
- > Manual drive.



J

## OVERFLOW SINGLE SEAT VALVE

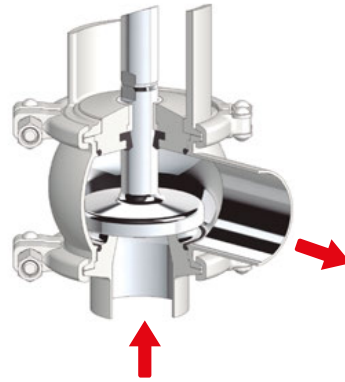

The INNOVA J-type valve is a pneumatic single seat valve designed for use as overflow valve in hygienic installations.

Its most important applications involve operating as a by-pass valve for positive displacement pumps or protecting equipment against excessive pressure.

Adjusting the screw on the upper part sets the spring pressure, which sets the valve's closing pressure.

The valve comes with an actuator that enables liquid to flow during CIP cleaning processes.

### HOUSING COMBINATIONS

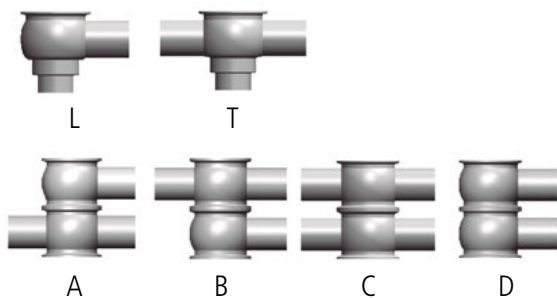

### OPTIONS

- > External position sensors.
- > Heating jacketed body.
- > Steam barrier.
- > Factory calibration.



F

## TANK BOTTOM SINGLE SEAT VALVE



The INNOVA F-type valve is a shut-off single seat valve designed specifically for installation at the tank bottom for use in hygienic applications.

It has an outlet with a 45° bend in order to allow welding to the installation. It has a specific body with an integrated flange.

### HOUSING COMBINATIONS



L











T

### OPTIONS

- > Double acting pneumatic actuator.
- > External position sensors.
- > Heating jacketed body.
- > Steam barrier.
- > Manual drive.
- > Twin stop.





		Gasket material			Surface finish			Available sizes		Connections			C			
		EPDM*	FPM	HNBR	Polish Ra ≤ 0,8 µm*	Polish Ra ≤ 0,5 µm	Matt	DIN EN 10357 series A	ASTM A269/270	Welded	Male	Clamp				
<b>N</b>		Shut-off	✓	✓	✓	Internal	Internal	External	DN 25 - DN 100	OD 1" - OD 4"	✓	✓	✓	✓	✓	✓
<b>M</b>		Shut-off	✓	✓	✓	Internal	Internal	External	DN 25 - DN 100	OD 1" - OD 4"	✓	✓	✓	✓	✓	✓
<b>K</b>		Divergent	✓	✓	✓	Internal	Internal	External	DN 25 - DN 100	OD 1" - OD 4"	✓	✓	✓	✓	✓	✓
<b>L</b>		Divergent	✓	✓	✓	Internal	Internal	External	DN 25 - DN 100	OD 1" - OD 4"	✓	✓	✓	✓	✓	✓
<b>J</b>		Overflow	✓	✓	✓	Internal	Internal	External	DN 25 - DN 80	OD 1" - OD 3'	✓	✓	✓	-	-	-
<b>G</b>		Control	✓	✓	✓	Internal	Internal	External	DN 25 - DN 100	OD 1" - OD 4'	✓	✓	✓	-	-	-
<b>F</b>		Tank bottom	✓	✓	✓	Internal	Internal	External	DN 25 - DN 100	OD 1" - OD 4'	✓	✓	✓	✓	✓	✓

\*Standard configuration

Control head				Housing combination			Certifications					Options						
Burkert Element 8691	Burkert Element 8692	Burkert Element 8693	Burkert Element 8694	1 body	2 bodies	3 bodies	eLFCG	A3	FDA	USDA	Ex	Double-acting pneumatic actuator	External position sensors	Heating jacket	Steam barrier	Manual action	Welded bodies	Twin stop
✓	-	-	-	L T	A B C D	-	✓	✓	✓	✓	✓	✓	✓	✓	✓	✓	-	✓
✓	-	-	-	-	A B C D	-	-	-	✓	✓	✓	✓	✓	✓	✓	✓	-	✓
✓	-	-	-	-	H E F G	J P R S V W X Z	-	✓	✓	✓	✓	✓	✓	✓	✓	✓	-	✓
✓	-	-	-	-	-	J P R S V W X Z	-	-	✓	✓	✓	✓	✓	✓	✓	✓	-	✓
-	-	-	-	L T	A B C D	-	-	-	✓	✓	✓	-	✓	✓	✓	✓	-	-
-	✓	✓	✓	L T	A B C D	-	-	-	✓	✓	-	✓	-	✓	✓	✓	-	-
✓	-	-	-	L T	-	-	-	-	✓	✓	✓	✓	✓	✓	✓	✓	-	✓

# MIXPROOF CONCEPT

The double seat mixproof valves allow a safe separation between two lines mainly in cleaning processes, thus precluding the possibility of contamination of the product. A balanced lower seat protects against water hammering. The mixproof shut-off valves are usually used in manifolds.

## TECHNICAL SPECIFICATIONS

DIN EN 10357 series A  
ASTM A269/270

DN 25- DN 100  
OD 1" - OD 4"

A balanced lower seat protects against water hammering.  
No leakage during the opening/closing of the valve.

## OPERATING PRINCIPLE

The seals are cleaned by means of "pulsing", which is the quick opening and closing of the independent valve shafts/plugs.

Any leakage in the seat seal is detected at the bottom of the valve.

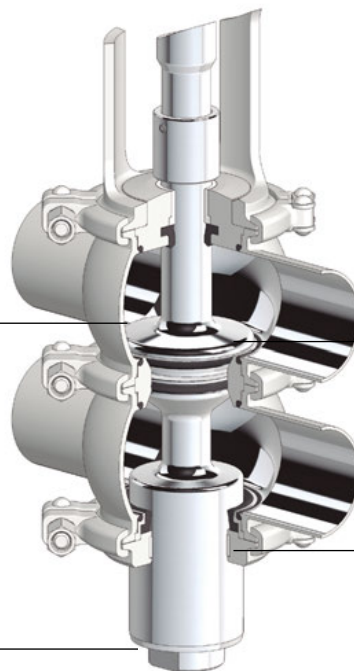

The double seat creates a central leakage detection chamber that in turn separates the two bodies.



Allows for CIP cleaning, avoiding any product contamination.

The balanced shaft provides protection against pressure surges and water hammering.

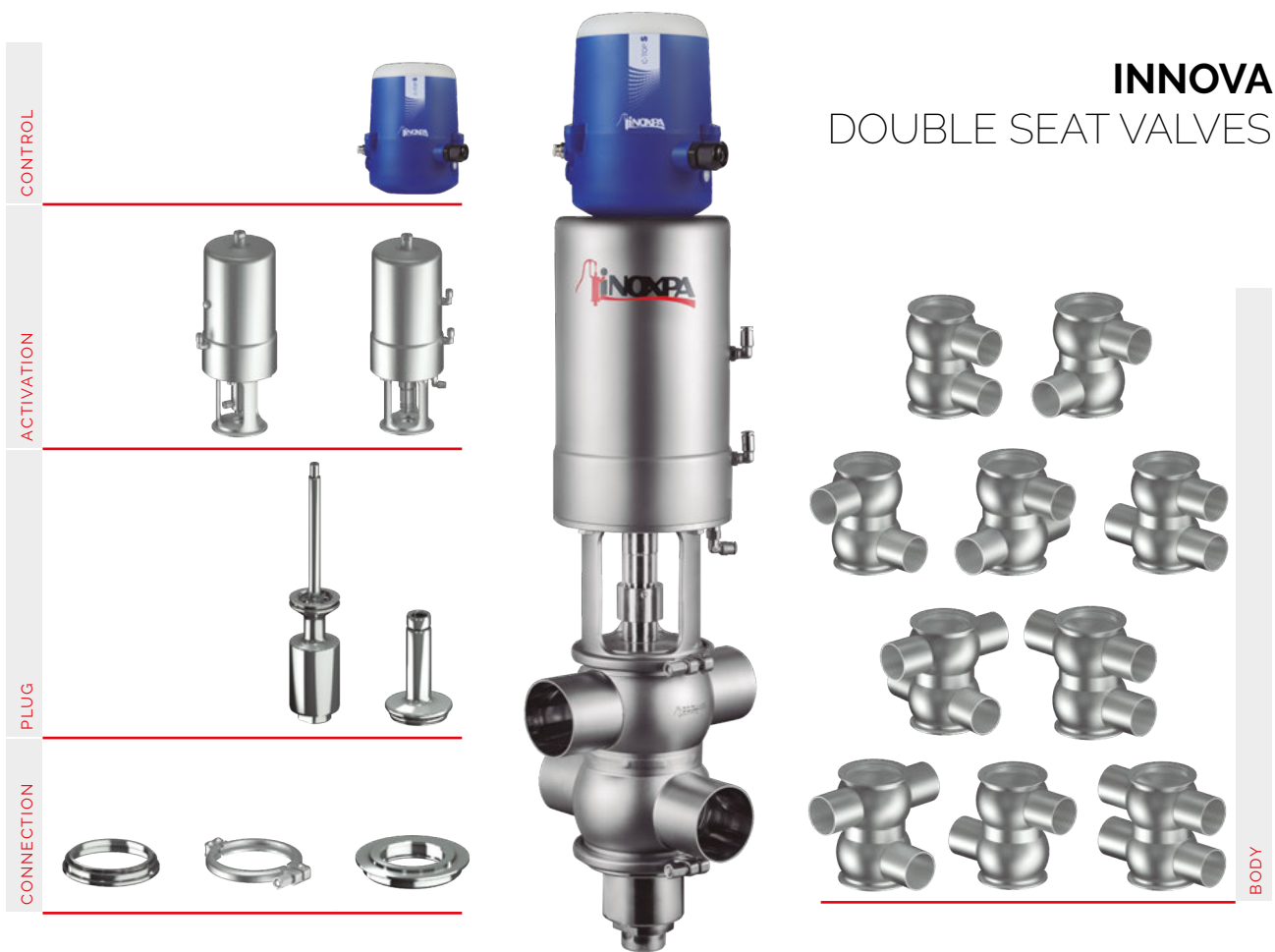

**INNOVA**  
DOUBLE SEAT VALVES

**INNOVA**  
DOUBLE SEAT  
TANK BOTTOM VALVES

**INNOVA**  
DOUBLE SEAL VALVES

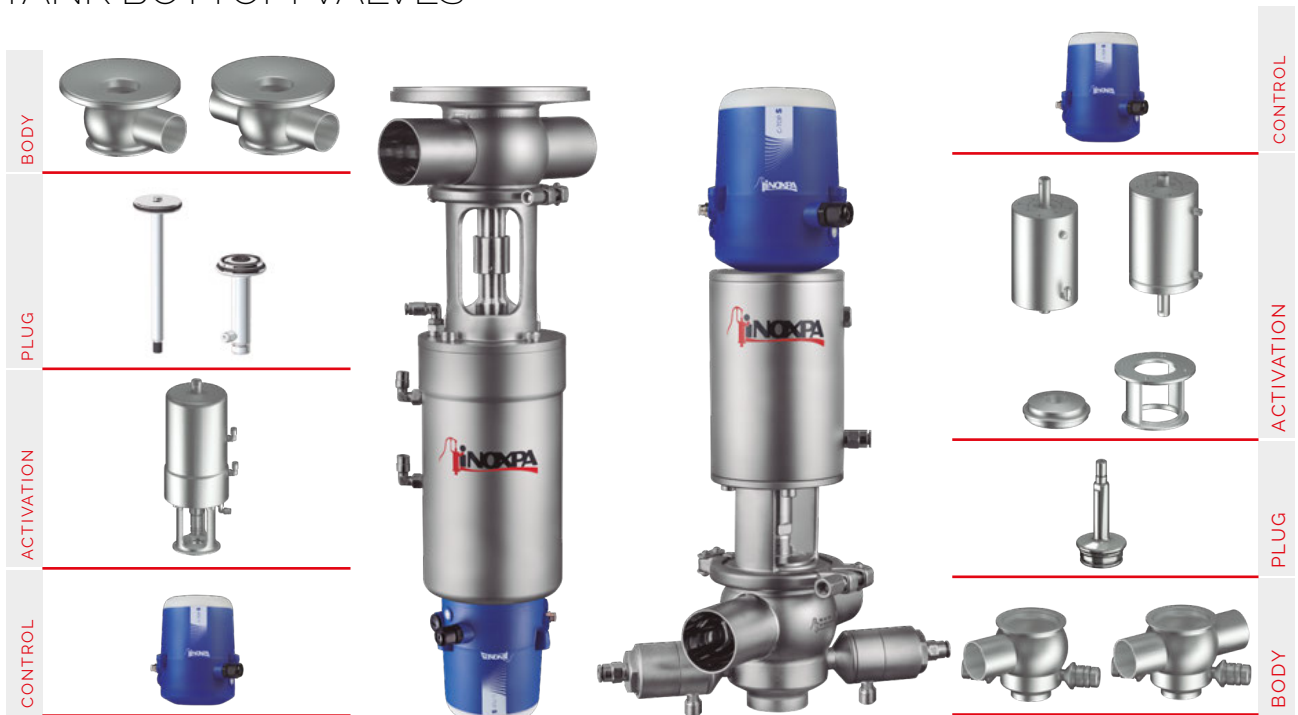



**SHUT-OFF  
SEAT LIFT  
DOUBLE  
SEAT  
MIXPROOF  
VALVE**

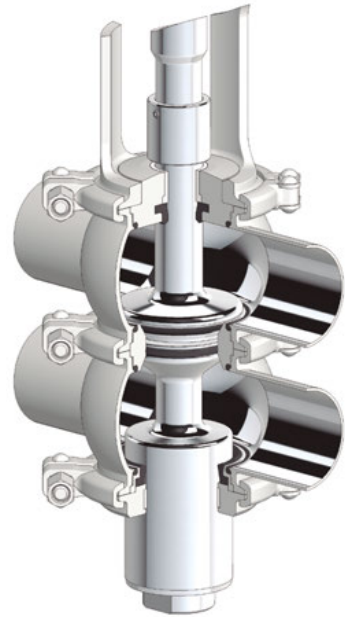

The INNOVA P-type valve is a pneumatic shut-off double seat valve for hygienic applications. The leakage detection chamber, under atmospheric pressure, formed between both seats ensures a safe interface between the two liquids, one of which is usually a CIP solution (cleaning agent).

The leakage chamber can be cleaned by independent lifting of the seats during the CIP cleaning of the line.

Valve designed by using FEA and CFD simulations in order to ensure an optimal KV.

Specific bodies for DIN and OD dimensions for a better drainability.

Seat seal with compression control by means of metal-metal contact.

Minimal maintenance.

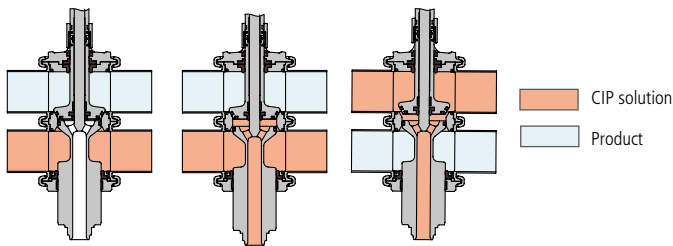

**HOUSING COMBINATIONS**

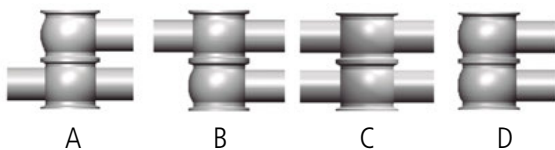

**OPTIONS**

- > External position sensors.
- > Welded bodies.



**SHUT-OFF  
CAVITY  
SPRAY  
DOUBLE  
SEAT  
MIXPROOF  
VALVE**

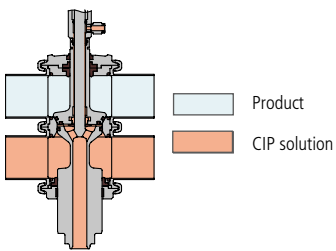
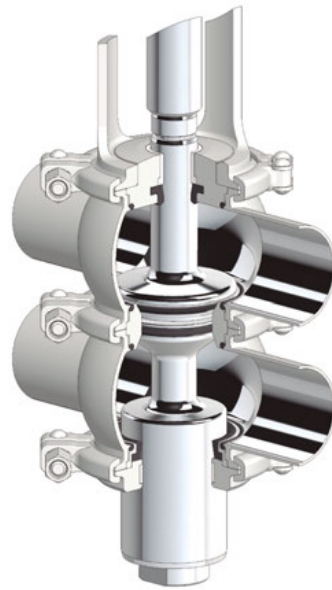

The INNOVA S-type valve is a pneumatic shut-off double seat valve for hygienic applications. The leakage detection chamber, under atmospheric pressure, formed between both seats ensures a safe interface between the two liquids, one of which is usually a CIP solution (cleaning agent).

The leakage chamber is cleaned via the CIP nozzle situated in the lantern.

**HOUSING COMBINATIONS**

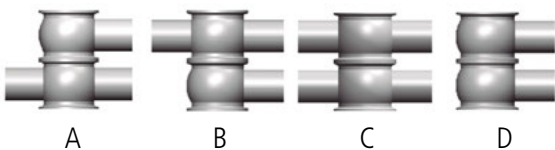

**OPTIONS**

- > External position sensors.
- > Heating jacketed body.
- > Welded bodies.



**TANK  
BOTTOM  
DOUBLE  
SEAT  
MIXPROOF  
VALVE**

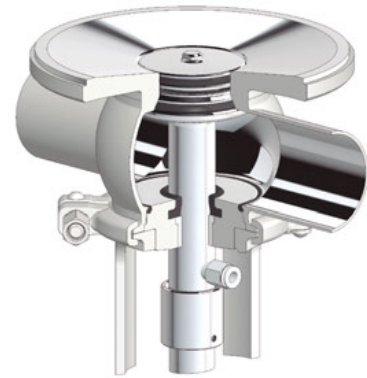

The INNOVA T-type mixproof valve is a double seat pneumatic shut-off valve designed specifically for use in tanks and vats used for hygienic applications. The leakage detection chamber, under atmospheric pressure, formed between both seats ensures a safe interface between the two liquids, one of which is usually CIP (cleaning agent).

**HOUSING COMBINATIONS**



**OPTIONS**

- > External position sensors.
- > Heating jacketed body.



**R**

# DIVERT DOUBLE SEAT MIXPROOF VALVE

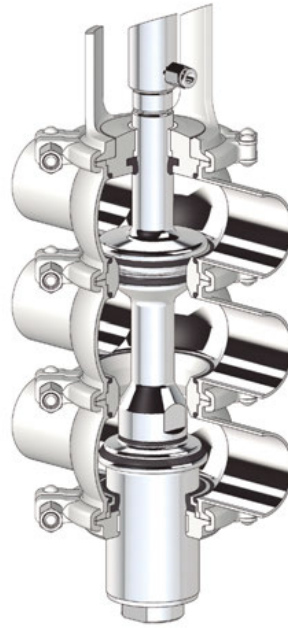

The INNOVA R-type valve is a pneumatic divert double seat valve for hygienic applications. The leakage detection chamber, under atmospheric pressure, formed between double upper seat ensures a safe interface between the two liquids, one of which is usually a CIP solution (cleaning agent).

The leakage chamber can be cleaned by independent lifting of the seats during the CIP cleaning of the line.

Valve designed by using FEA and CFD simulations in order to ensure an optimal KV.

Specific bodies for DIN and OD dimensions for a better drainability.

Seat seal with compression control by means of metal-metal contact.

Minimal maintenance.

## HOUSING COMBINATIONS

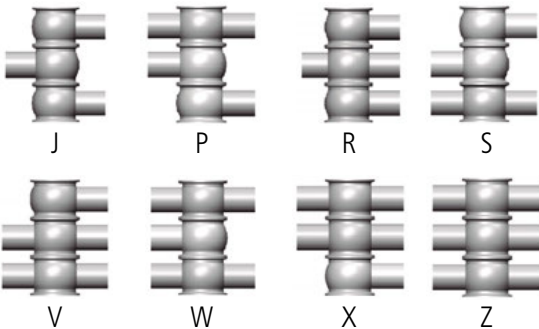

## OPTIONS

- > External position sensors.
- > Heating jacketed body.
- > Welded bodies.



# DOUBLE SEAT MIXPROOF VALVE

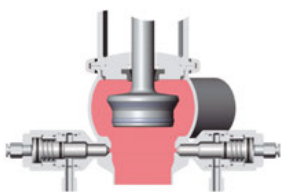
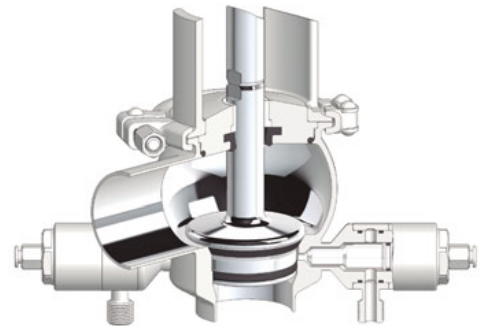

Valve open.  
Leakage valves closed.

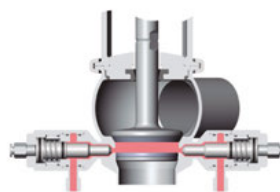

Valve closed.  
Leakage valves open for draining or cleaning of the leakage chamber.

The INNOVA D-type valve is a pneumatic shut-off single seat valve with two seals. The leakage detection chamber, under atmospheric pressure, formed between the seals ensures a safe interface between the two liquids, one of which is usually CIP (cleaning agent).



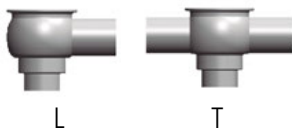

## HOUSING COMBINATIONS



## OPTIONS

- > External position sensors.
- > Heating jacketed body.
- > Steam barrier.
- > Twin stop.



	Gasket material	Surface finish			Available sizes		Connections			C-TOP S			C-TOP+	Burkert Element 8690		
		EPDM*	FPM	HNBR	Polish Ra ≤ 0,8 µm*	Polish Ra ≤ 0,5 µm	Matt	DIN EN 10357 series A	ASTM A269/270	Welded	Male	Clamp				
<b>P</b>		Shut-off seat lift valve	✓	✓	✓	Internal	Internal	External	DN 40 - DN 100	OD 1 ½" - OD 4"	✓	✓	✓	-	✓	✓
<b>S</b>		Shut-off cavity spray valve	✓	✓	✓	Internal	Internal	External	DN 40 - DN 100	OD 1 ½" - OD 4"	✓	✓	✓	-	✓	✓
<b>T</b>		Bottom tank mixproof valve	✓	✓	✓	Internal	Internal	External	DN 40 - DN 100	OD 1 ½" - OD 4"	✓	✓	✓	-	✓	✓
<b>R</b>		Divert double seat mixproof valve	✓	✓	✓	-	-	✓	DN 40 - DN 100	OD 1 ½" - OD 4"	✓	✓	✓	✓	✓	✓
<b>D</b>		Double seal mixproof valve	✓	✓	✓	Internal	Internal	External	DN 25 - DN 100	OD 1" - OD 4"	✓	✓	✓	✓	✓	✓

\*Standard configuration

Control head				Housing combination			Certifications					Options						
Burkert Element 8691	Burkert Element 8692	Burkert Element 8693	Burkert Element 8694	1 body	2 bodies	3 bodies						Double-acting pneumatic actuator	External position sensors	Heating jacket	Steam barrier	Manual action	Welded bodies	Twin stop
✓	-	-	-	-	A B C	-	-	-	✓	✓	✓	-	✓	✓	-	-	✓	-
✓	-	-	-	-	A B C D	-	-	-	✓	✓	✓	-	✓	✓	-	-	✓	-
✓	-	-	-	L T	-	-	-	-	✓	✓	-	-	✓	✓	-	-	-	-
✓	-	-	-	-	J P R S	V W X Z	-	-	✓	✓	-	-	✓	✓	-	-	-	-
✓	-	-	-	L T	-	-	-	-	✓	✓	-	✓	✓	✓	✓	✓	-	-

# MANIFOLDS

## FUNCTION

Manifolds of the INOXPA valves allow to centralize the functions of various tanks in a modular way, enhancing the efficiency of the system and control over the process.

The automation of the operation results in safety, flexibility and it will pay off its cost very fast.

One manifold applied to various lines allows cleaning of one tank while the other is being filled or emptied preventing any risk of product contamination.

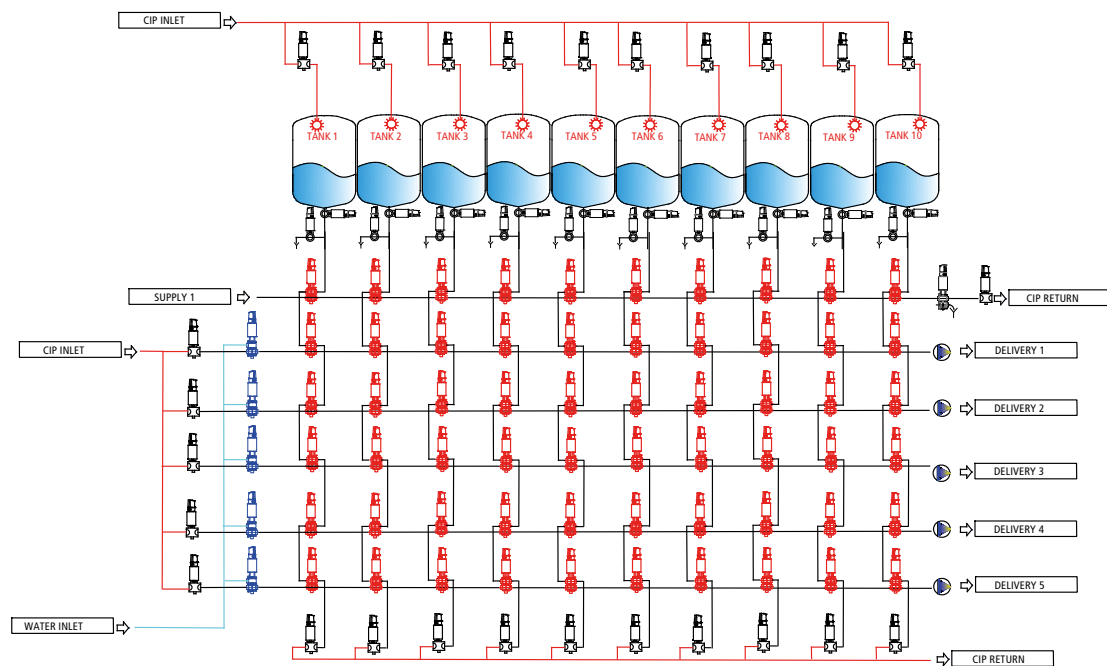



## DESIGN AND FEATURES

- It consists of a matrix of valves, their quantity depends on the elements to be connected (tanks or lines), and on the functions of each of these elements.
- The Mixproof pneumatic valves (multi-way double seat valves) prevent any leakage from one body to the other.
- Normally, valves are provided with a control unit C-TOP+ with solenoid valves and sensors.
- An air distribution collector is included and provided with the maintenance kit and a shut-off valve for each actuator.
- The cleaning of the Mixproof valves is by Cavity Spray (INNOVA S) or Seat Lift (INNOVA P) systems.
- If the Cavity Spray valves are selected, the kit also contains one collector of the cleaning distribution system for the CIP connection. This collector consists of a butterfly valve and a filter.
- Under the manifold of valves and pipes there is a kind of inclined tray that collects drained products (due to leakage or cleaning process) from the manifold.
- The unit is provided with a control panel, pneumatic and electric distribution system to facilitate the installation.

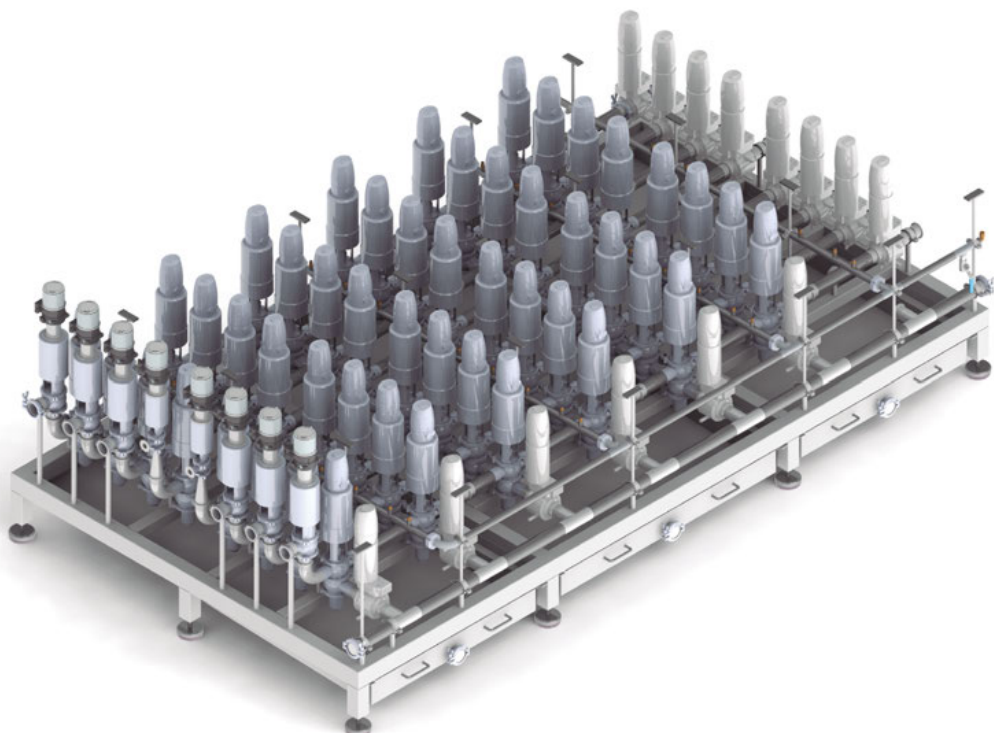

# CTOP S

## APPLICATION

The C-TOP S control unit can adapt to any INOXPA actuator, and both efficiently and individually automate pneumatically driven process valves. These include: butterfly, ball, diaphragm and single or double seat valves.



## OPERATING PRINCIPLE

The control unit contains a linear detection electronic module comprised of several hall sensors.

A PLC system sends signals to the solenoid valves through the unit's electronic module to control and operate the main valve. At the same time, the electronic module sends return signals to the PLC to indicate the valve's current position. The C-TOP S is configured using the electronic module's buttons. A specific colour for each valve position lights up to indicate the valve's current status at all times. The unit's coloured lights can be configured using the DIP switches that are also found on the electronic module.



## DESIGN AND FEATURES

The C-TOP S installs easily onto the top of the valve's actuator. AUTOTUNE mode enables quick and simple configuration. Line detection using hall sensors. Use of up to three solenoid valves possible. One solenoid valve is required for single-acting control valves, two for double-acting control valves, and three for mixproof valves. External sensor connection possible. 360° view of lights indicating valve status.



Digital



AS-I





Version up to 1 solenoid valve and 3 outputs



Version up to 3 solenoid valves and 4 outputs



AS-I Version

### 24 V DC DIGITAL COMMUNICATION

Voltage supply	24 V DC $\pm$ 10%
Outputs	PNP normally open
Terminal	Push-in type, nominal cable section from 0.2 to 1.5 mm <sup>2</sup> (22AWG to 16AWG)
Main input	M16 stuffing gland x 1.5 (4 to 10 mm diameter cable)
External sensor input	M16 plug x 1.5

### AS-INTERFACE COMMUNICATION



















Voltage supply	AS-i cable from 29.5 to 31.6 V DC
Terminal	Push-in type, nominal cable section from 0.2 to 1.5 mm <sup>2</sup> (22AWG to 16AWG)
Main input	M16 stuffing gland x 1.5 with a 2 m cable and a 4 pole male M12 connector
External sensor input	M16 plug x 1.5
Version	v3.0 (A/B addressing and up to 62 nodes)
Slave profile	7A77



IDENTIFICATION OF THE VALVE

Each valve is inscribed with its fabrication number. Indicate the fabrication number on all documents to refer to the valve.

INOXPA S.A.U. C. TELERS 60 - 17820 BANYOLES GIRONA (SPAIN) - www.inoxpa.com		CE EAC	
ITEM: WATT0-00652040110	SIZE: DN 50		
TYPE: INNOVA TT DIN EPDM FDA ACT. T1 S/E NC			
WORKING PRESSURE: 10 bar / 145 psi			
AIR PRESSURE: Min. 6 bar / 87 psi Max. 8 bar / 116 psi			
PRODUCTION NR: I254782	YEAR: 2019		

WA	T	T	0	-	0	06	52	040	11	0	EX
											Option ATEX
											EX Atex
											Options Ra
											0 ID Ra<0,8
											1 ID Ra<0,5
											Actuator
											11 T1 S/E NC 23 T3 S/E NO
											12 T2 S/E NC 24 T4 S7E NO
											13 T3 S/E NC 31 T1 D/E
											14 T4 S/E NC 32 T2 D/E
											21 T1 S/E NO 33 T3 D/E
											22 T2 S/E NO 34 T4 D/E
											Size
											025 DN 25, OD 1 065 DN 65
											040 DN 40, OD 1 1/2" 076 OD 3"
											050 DN 50, OD 2" 080 DN 80
											063 OD 2" 1/2" 100 DN 100, OD 4"
											Gaskets
											43 HNBR
											52 EPDM
											78 FPM
											Material
											06 AISI 316L
											Conections
											0 Welded
											1 Male
											7 Clamp
											Standard pipe
											0 DIN
											1 OD
											Bodies configuration
											N,T   1 body
											A,B,C,D     2 bodies    
											J,P,R,S,V,W,X,Z     3 bodies    
											Types
											N Shut-off valve (direct acting)
											M Shut-off valve (reverse acting)
											K Routing valve (converging flow)
											L Routing valve (diverging flow)
											F Tank bottom valve
											J Overflow valve
											G Control valve
											P Mixproof valve (seat lift)
											S Mixproof valve (cavity spray)
											D Leakage detector
											T Mixproof tank bottom valve (Seat lift)
											R Mixproof routing (Seat lift)
											Product family
											WA INNOVA valve





**INOXPA S.A.U.**  
Telers, 60  
17820 Banyoles - Spain  
Tel. +34 972 57 52 00  
inoxpa@inoxpa.com

**[www.inoxpa.com](http://www.inoxpa.com)**

INNOVA.0923.EN